

VITA VACUMAT® 40 T

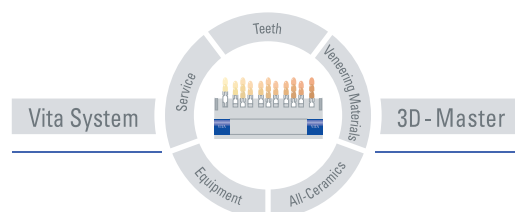

Operating manual

Date of issue: 05-07



VITA

Table of Contents

1 FOREWORD	5
1.1 PICTOGRAMS.....	5
1.2 COPYRIGHT	5
2 TECHNICAL INFORMATION	6
2.1 GENERAL DESCRIPTION	6
2.2 EXTERNAL CONTROL EQUIPPED WITH.....	6
3 PROGRAM POSSIBILITIES	7
3.1 FIRING PROGRAMS.....	7
3.2 SERVICE PROGRAMS (SEE ALSO SECTION 19).....	7
4 SAVING OF FIRING DATA FOR QUALITY ASSURANCE	7
5 SAFETY FUNCTIONS	7
6 DIMENSIONS/WEIGHTS	8
6.1 FIRING UNIT	8
6.2 CONTROL UNIT	8
6.3 ELECTRIC DATA FIRING UNIT/CONTROL UNIT	8
6.4 VACUUM PUMP (ACCESSORY) ELECTRICAL DATA	8
6.5 SCOPE OF DELIVERY.....	8
7 INSTALLATION AND START-UP	9
7.1 MOUNTING LOCATION.....	9
7.2 CONNECTING THE UNIT TO THE MAINS SUPPLY.....	10
7.3 SHUTTING DOWN THE UNIT, OUT OF OPERATION.....	11
7.4 NIGHT MODE.....	11
8 NOTES ON SAFETY	11
8.1 INTENDED USE	11
8.2 NOTES ON INFORMATION DECALS.....	12
8.3 CLEANING THE FIRING UNIT.....	13
8.4 OPERATION AND CLEANING OF THE CONTROL UNIT.....	13
8.5 FUSES.....	13
8.6 CE – SIGN	13
8.7 FAN.....	14
8.8 VOLTAGE SUPPLY FAILURE.....	14
8.9 THE WARRANTY AND LIABILITY DEPENDS ON THE CONDITIONS AGREED UPON BY CONTRACT.....	14
8.10 SPARE PARTS.....	14
9 TEMPERATURE RISE	15
10 AUTOMATIC TEMPERATURE ADJUSTMENT	15
11 GENERAL OPERATION OF UNIT	16
11.1 NUMERICAL INPUTS.....	16
11.2 ALPHA NUMERICAL INPUTS.....	17
11.3 QUICKSTARTING A FIRING PROGRAM – QUICKSTART	17
12 START MENU	18
13 STANDBY	19
13.1 ADJUSTMENT OF STANDBY TEMPERATURE.....	19
13.2 START/STOP STANDBY MODE.....	20

14 SELECTING A FIRING PROGRAM.....	21
15 CHANGING PROGRAM VALUES.....	23
16 LIFT POSITIONS FOR PRE-DRYING	24
16.1 DIRECT INPUT OF CHANGES FOR LIFT POSITION AND POSITION TIME.....	25
16.2 INPUT OF CHANGES TO LIFT POSITION AND POSITION TIME IN THE PRE-DRYING MENU ..	26
17 LIFT POSITIONS FOR COOLING	28
17.1 DIRECT INPUT OF CHANGES TO THE LIFT POSITION COOLING	28
17.2 ENTERING A CHANGE OF LIFT POSITION COOLING IN THE COOLING MENU.....	29
18 VACUUM SETTINGS.....	31
19 SERVICE PROGRAMS.....	33
19.1 INFORMATION ABOUT THE UNIT/SOFTWARE.....	33
19.2 LANGUAGE SELECTION.....	33
19.3 EXPORT FAILURE REPORT	34
19.4 SCREEN SETTINGS	34
19.5 PROCESS DATA.....	34
19.6 LOADING FIRING PROGRAMS FROM THE MEMORY STICK	34
19.7 DATE - TIME.....	35
19.8 DISPLAY FORMAT.....	35
19.9 LIFT SPEED ADJUSTMENT	36
19.10 OPERATING DATA	36
19.11 TEMPERATURE CALIBRATION BY MEANS OF SILVER TEST.....	37
19.12 VACUUM CALIBRATION	37
19.13 PROGRAMS	38
19.14 MELODY FOR END OF PROGRAM	38
19.15 DRY – PROGRAM (VITA IN-CERAM SPRINT).....	38
20 SOFTWARE UPDATE	39
21 FACTORY SETTINGS	39
22 ERROR MESSAGES	40
23 FIRING TABLES	42
23.1 VITA VM 7.....	42
23.2 VITA VM 9.....	42
23.3 VITA VM9 VITABLOCS®.....	43
23.4 VITA VM 13.....	43
23.5 VITA VM 15.....	44
23.6 VITA VMK 95	45
23.7 VITA OMEGA 900.....	46
23.8 VITA TITANIUM PORCELAIN	46
23.9 SOLDERING IN VITA VACUMAT 40 T.....	47
23.10 TEMPLATE FOR CUSTOMIZED PROGRAMS.....	48

1 Foreword

These operating instructions provide a considerable help for successful and risk free operation of the unit.

The operating instructions contain important information for safe, proper and economical operation of the equipment. Compliance with these instructions helps to avoid dangers, to reduce repair costs and downtimes and to enhance the reliability and the service life of the unit.

The illustrations and drawings in these operating instructions serve the general clarification and are by no means substantial the details of the equipment design.

The operating instructions must be available near the unit at any time. They must be read and applied by all persons involved in work on/with the unit, such as.:

- operation,
- troubleshooting and fault rectification during operation,
- care,
- upkeep (maintenance, inspections, repair).

1.1 Pictograms



This pictogram warns of dangerous voltage. Before opening the unit it must be isolated from the power supply by pulling out the mains plug.



This pictogram warns of hot surfaces. Injuries by burning are possible.



Please note that electrical/electronic units must be disposed of separately. Do not dispose with household waste. The black bar below the "garbage bin" symbol indicates that the unit was put into circulation after August 13, 2005. Please note that the unit is subject to regulation 2002/96/EC (WEEE) and applicable national laws and must be disposed of accordingly. Please contact your dealer if the unit needs to be disposed of.



This pictogram draws the attention to dangerous situation with the possible risk of personal injury or damage to the equipment.



This pictogram highlights useful hints, explanations and additional information concerning handling of the unit.

1.2 Copyright

These operating instructions must be treated confidentially. They should only be used by authorized persons. Disclosure to third parties is only permitted with the written approval of VITA Zahnfabrik H. Rauter GmbH & Co. KG.

All documents are protected by copyright law.

Any disclosure as well as the reproduction of documents, even in form of excerpts, utilization and publication of its content is not permitted, if not explicitly approved. Violations are liable to prosecution and oblige to compensation.

All rights concerning the exercise of industrial property rights remain reserved.

2 Technical information

2.1 General description

- Powerful in technology – highest temperature accuracy temperature sensors
- Time saving operating comfort – moderate spatial requirements – optimal firing results
- Housing made of paint finished sheet steel and stainless steel
- Firing charge rack
- Firing chamber furnished with high quality insulating material
- Quart material firing muffle
- Automatic temperature adjustment
- Temperature accuracy plus/minus 2 °C

2.2 External control equipped with

- Clearly laid out colour touchscreen display
- Clearly arranged and self-explaining operation
- Operation related notes for possible inputs
- Internal memory for approx. 200 firing programs
- Software updates via Memory Stick

3 Program possibilities

3.1 Firing programs

- Memory capacity for approx. 200 firing programs.
- Setting the standby temperature (see also section 13).
- Free programming of 3 lift positions and interval times for pre-drying (see also section 16).
- Temperature rise with simultaneous activation of the vacuum pump.
- Changing of program values for one-time program sequence (see also section 15).
- Free programming of lift position for cooling (see also section 17).
- Adjustable vacuum time.
- Opening of the firing chamber while maintaining the standby temperature (see also section 13.2).
- Standby – mode night program (see also section 14).
- Rapid cooling to standby temperature after expiration of program (see also section 14).

3.2 Service programs (see also section 19)

- Language selection (D, E, F, SP, I)
- Information (software, software update, equipment-no., Service e-mail)
- Display brightness / contrast control
- Saving – exporting process data
- Setting Date / Time
- Format – display of temperature °C or °F, date / time 24h/am/pm.
- Adjustment of lift speed.
- Operating data (total operating hours, operating hours of firing muffle, information concerning the firing muffle, number of firing programs started)
- Calibration (program for silver test, input for temperature offset, vacuum adjustment)
- Termination of program (press "Stop" button 1 or 2 times)

4 Saving of firing data for quality assurance

- Saving of firing data nominal and actual values (see also section 19.5)
- Saving of user name, equipment-no., date of firing incident, job-no.,
- These data are saved to the memory of the control unit and exported to the management program (FDS – Firing – Data – System) on the PC by means of a Memory Stick.



* Management program FDS is special accessory and must be ordered separately.

5 Safety functions

- Temperature sensor monitoring
- Temperature monitoring
- Vacuum monitoring
- Power failure protection (see also section 8.8).
- Lift monitoring

6 Dimensions/weights

6.1 Firing unit

- Width: 220 mm
- Depth: 320 mm
- Height: 420 mm
- Housing: Steel/stainless steel
- Weight: 10,0 kg
- Firing chamber capacity: Diameter: 90 mm
Height: 55 mm
- Firing chamber temperature: max. 1200 °C

6.2 Control unit

- Width: 195 mm
- Depth: 150 mm
- Height: 150 mm
- Housing: Steel/stainless steel
- Weight: 1.0 kg

6.3 Electric data firing unit/control unit

- Electric connection: 230 Volt AC, 50 Hz
or 100/110 Volt AC, 50/60Hz
- Wattage: max. 1500 Watt

6.4 Vacuum pump (accessory) electrical data

- Electric connection: 230 Volt, 50/60 Hz
or 100/110 Volt, 50/60 Hz
- Wattage: max. 0.2 kW
- Weight: approx. 6.4 kg

6.5 Scope of delivery

Unit in special cardboard box, complete with:

- 1 control unit
- 1 Connecting cable for control unit
- 1 Firing socket
- 1 Connecting cable for mains supply
- 1 Core pincers
- 1 Package with firing carriers A + B
- 1 Package with firing supports G
- 1 Operating instructions
- 1 Stylus for control unit

Special accessories on request:

- Vacuum pump: 230 Volt, 50/60 Hz
or 100/110 Volt, 50/60 Hz
- Management program FDS (see also section □).

7 Installation and start-up

7.1 Mounting location

- Install the unit in a dry, heated room with a clearance of at least 25 cm to the nearest wall.
- With temperatures below 15 °C (e.g. after transport) let the unit rest for about 30 minutes at room temperature before starting it up.
- Make sure the unit is standing on a temperature resistant surface. The radiation and heat development is within a harmless range. However, it cannot be completely ruled out that sensitive furniture surfaces and veneers will show slight discoloration caused by the permanent exposure to heat over the course of time.
- Avoid exposure to direct sunlight.
- Do not place any inflammable objects near the unit.
- Do not place the control unit into the direct heat emission range of the firing chamber.



Abb. 1

- 1 Rack for firing objects
- 2 Main switch
- 3 Vacuum connection
- 4 Connection, vacuum pump
- 5 Mains connection
- 6 Fuses

7.2 Connecting the unit to the mains supply

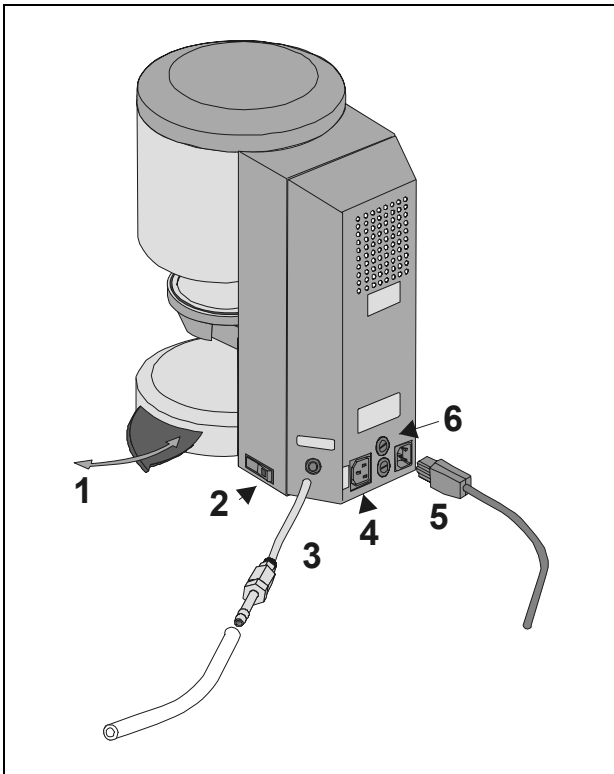

Before start-up read section 8 "Notes on safety"!



Abb. 2
1 Control unit
2 Firing socket

- Plug the connecting cable into control unit (2/1) and firing unit.
- Connect the vacuum pump (Abb. 1)
- Use the supplied mains lead to connect the unit to the mains supply (Abb. 1). The connecting cable should be a hot equipment supply lead of type HO5RR-F 3G1,0 mm². Avoid connecting to a multiple socket outlet with extension lead, because there is a risk of fire when overloaded.
- Switch on the unit by the main switch, the lift moves to bottom position.
- Clean lift plate and lift plate seal (dust particles resulting from the transport of the unit).
- Place the firing socket (2/2) on the lift plate.
- Press button "Start" to activate standby mode (see also section 13).

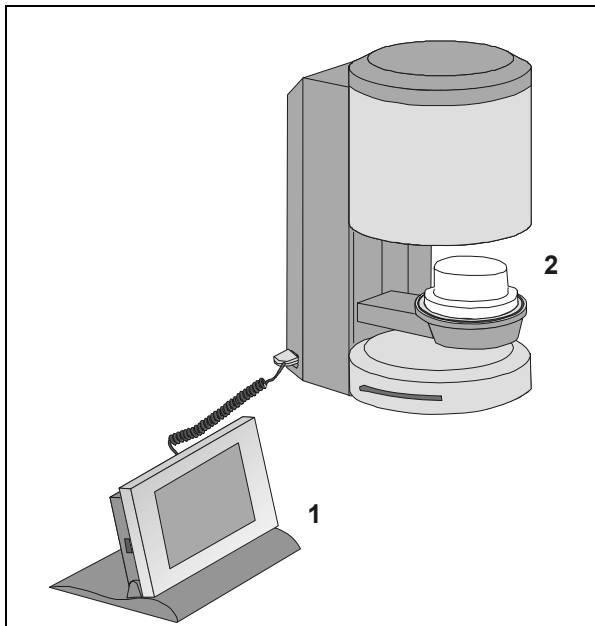

During initial start-up of the unit enter Date / Time.

- Input Date: DD.MM.YY.
- Input Time: HH:MM
- Press button "OK" – the display shows the main menu.

see also section 19.7

7.3 Shutting down the unit, out of operation

If the unit is not used the lift should be retracted into the firing chamber and the unit switched off by the main switch (see Fig. 1, item 2). Closing the firing chamber protects the insulation and prevents the absorption of moisture.

To shut down the unit press the button with the switch-off symbol, the lift is automatically retracted, switch off the unit by the main switch (see also section 12).

7.4 Night mode

After selecting a firing program there is also the possibility to activate the automatic shutdown.



After expiry of the firing program and cooling down of the firing chamber to 200 °C the lift is automatically retracted and the unit switched to standby mode.

8 Notes on safety



For your own personal safety you should thoroughly read the following notes on safety before starting operation of the unit.

8.1 Intended use

Basis for the design of the unit

The unit is of state of the art design and complies with the generally accepted rules concerning health and safety.

However, danger for the health and safety of the user or third parties as well as impairments of the unit and other material values may arise if the unit is improperly used.

Inadmissible modes of operation

Operation of the unit is not permitted

- with power sources, products etc. which are subject of a dangerous chemicals ordinance or which could affect the health of the operating personnel in any other way
- with equipment that has been changed by the user

Permitted modes of operation

Operation of this machine is only permitted if these operating instructions were read and understood and the procedures described are complied with.

Any other use and any use beyond these limits, such as the processing of products other than the ones specified and the handling of hazardous or health threatening substances, is considered as unintended use.

The manufacturer/supplier will not assume liability for damage resulting from this. The risk must solely be born by the user.



8.2 Notes on information decals

This symbol warns of dangerous voltage. Before opening the unit it must be isolated from the power supply by pulling out the mains plug.



After removing the back plate and with the unit switched off parts of the mains unit on the printed circuit board may still carry a remanent voltage of up to 400 Volt.

The manufacturer will not assume liability for accidents of the user caused by work on the opened unit.



Do not place any objects near the lifting plate (3/1). The lift will move down to bottom position when switching on the unit.

Use the laterally extendable rack (3/2) to deposit firing objects.

Never operate the units without the firing socket attached (Abb. 2).

In continuous operation (max. end temperature, max. firing time) parts of the firing chamber may reach increased temperatures (higher than 70 °C).

Do not reach with your hands into the open firing chamber when the unit is connected, there is a risk of touching electrically live or hot parts.

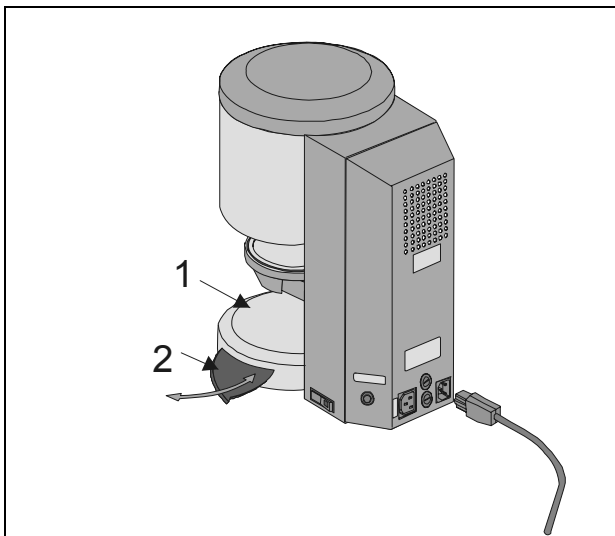

Fig. 3

- 1 Lift plate
- 2 Storage rack

8.3 Cleaning the firing unit

Pull out the mains plug before starting to clean!

Cleaning of the firing chamber from inside is not necessary, regular cleaning of the housing with a damp cloth enhances the operational reliability.

Do not use any cleansing agents or combustible fluids for cleaning .

8.4 Operation and cleaning of the control unit

The control unit is **solely** to be operated with the pin supplied for this purpose.

The use of other operating elements will cause damage to the touchscreen.

Clean the display at regular intervals with a screen cleansing agent.

Such cleansers do not leave any scratches, generate an anti-static effect and retard resoiling.

Damage to the display caused by inappropriate handling during operation or cleaning, are excluded from warranty.

8.5

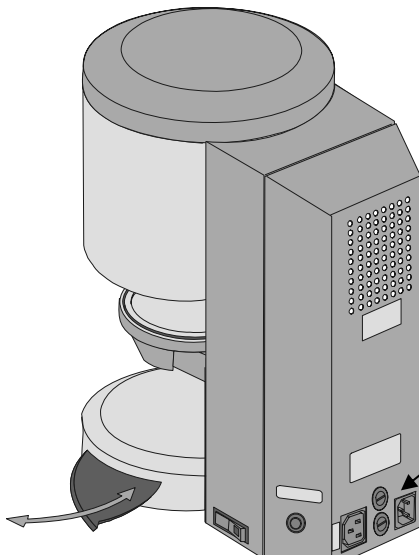

Fuses

2 fuses for the unit are installed on the rear side of the unit. The information decals provide information on the fuses used in the unit. Fuses with different capacity must not be used.

230 Volt version

T 8 H 250 V

100/110 Volt version

T 15 H 250 V



8.6 CE – Sign

The CE - mark entails a legally binding statement that the unit complies with the basic requirements, directive 73 / 23 / EEC, amended by directive 93/68/EEC, concerning electrical equipment.

We declare the conformity based on the following standards:

- Safety: IEC 610110-1:2001 2nd edition and IEC 610110-2-010:2003 2nd edition.

8.7 Fan

The unit is equipped with a fan. The fan is temperature regulated, switching on and off as well as the speed are automatically controlled.

The fan prevents excessive heating up of the unit and contributes to the general operational reliability. Failure of the fan is indicated by means of an error message in the display (see error messages). For safety reasons the unit should never be operated without fan. The top cover of the firing chamber and the openings in the rear cover must never be obstructed or blocked.

8.8 Voltage supply failure

The unit is equipped with a voltage failure protection . In case of a short-term voltage supply failure this element prevents a termination of the program with a resulting a firing fault. The voltage failure protection becomes effective as soon as the main voltage fails during a progressing firing program.

Mains voltage failure time less than approx. 10 sec.

The display is switched on again, the information field shows the information "Recover". This information is automatically deleted after expiration of the program, the program continues and is not aborted.

Mains voltage failure time longer than approx. 10 sec.

The program is terminated, the display is out of operation. Once the mains voltage is applied again, the display indicates a voltage failure for the reason of information, press the confirmation button to reset the message.



After the mains voltage is applied again the time needed to switch the control unit back on is approx. 20 sec.

8.9 The warranty and liability depends on the conditions agreed upon by contract.



Changes to the software without the knowledge of and approval by VITA Zahnfabrik H. Rauter GmbH & Co KG cause the exemption from liability and warranty.

8.10 Spare parts

Spare parts must comply with the technical requirements determined by the manufacturer. This is always assured when using original spare parts.

9 Temperature rise

In the program the temperature rise is displayed in °C/Min and in Min/sec. The input value can be selected between °C/Min (20 °C – 120 °C) or Min/sec. (2:00 – 40:00). The second value is automatically calculated and displayed. The input of values outside the permissible range will not be accepted and the last valid value will be displayed again. If the calculated temperature rise of 20°C/Min is fallen short of or the top value of 120 °C is exceeded because of the input of a temperature rise value in Min/sec, a valid temperature rise time in Min/sec is automatically entered.

If the pre-dryer temperature or the firing temperature is changed after the input of the temperature rise, the value °C/Min is corrected and the time in Min/sec is maintained, as long as the value is in the permissible range.

10 Automatic temperature adjustment.

The automatic temperature adjustment is performed after each start of a firing program.

This temperature adjustment accounts for or corrects all deviations of electronic components related to temperature measurement and temperature control that have occurred. This adjustment is made in 5 msec., the general course of time is thereby not affected. This ensures a uniform temperature performance of +/- 2 °C, even over a long operating time of the unit.

11 General operation of unit

The display is solely to be operated with the stylus supplied for this purpose.

i The use of other means for operation will cause damage to the touch-screen and possible malfunctions.

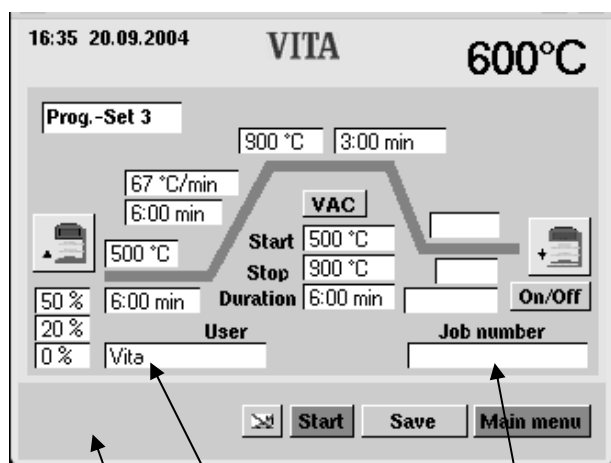

- 1 Info bar
Possible input values are displayed.
- 2 Input field for user
- 3 Input field for job number

11.1 Numerical inputs

i The fields "2" and "3" are only displayed if process data "ON" has been selected in the service menu, see also sections 4 and 19.5.

When clicking on fields for numerical input a keypad is displayed.

When clicking on fields for numerical input a keypad is displayed.

Click on a field:
The field is highlighted in colour. The input of a value deletes the existing value.

or

Touch the field with the pin behind the last digit:
The cursor is displayed. Use button "←" to delete the digits one by one.

i Input of time values always with colon, e.g.
time 0 input = 1:00 (Min/sec.)
or
6 Min = 6:00
Confirm value with "OK".

11.2 Alpha numerical inputs

When operating the input field for users (only visible if "ON" is selected in the service "process data" (see section 19.5 and 4)) the keypad is displayed.

Click on a field:

The field is highlighted in colour. The input of a value deletes the existing value.

or

Touch the field with the pin behind the last digit:

The cursor is displayed. Use button "←" to delete the digits one by one.

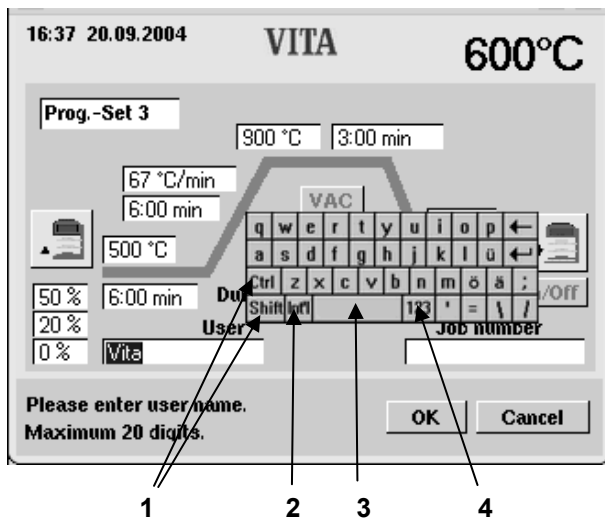

- 1 Shift-key
- 2 Special characters
- 3 Space key
- 4 Changeover key for numbers

11.3 Quickstarting a firing program – Quickstart

Quickstart is displayed if the firing chamber temperature is still higher than the selected pre-drying temperature when starting a firing program.

The opposite display appears on the screen.

The smaller temperature difference between pre-dryer temperature and end temperature results in a shorter rise time.

The temperature gradient is maintained and the adapted rise time is displayed.

Pressing button "Yes" starts the program immediately, when pressing button "No" the program is started after the firing temperature has reached the pre-drying temperature.

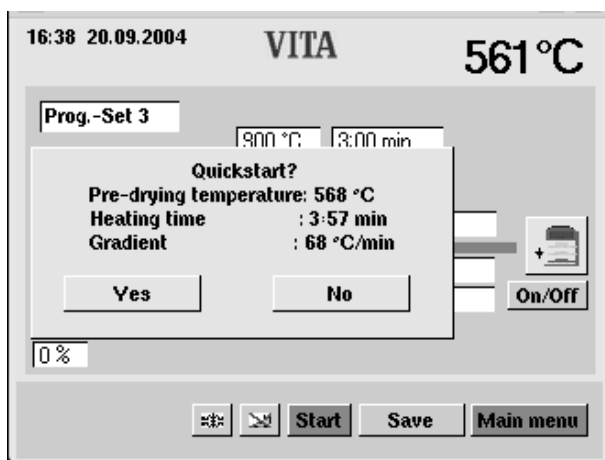

12 Start menu

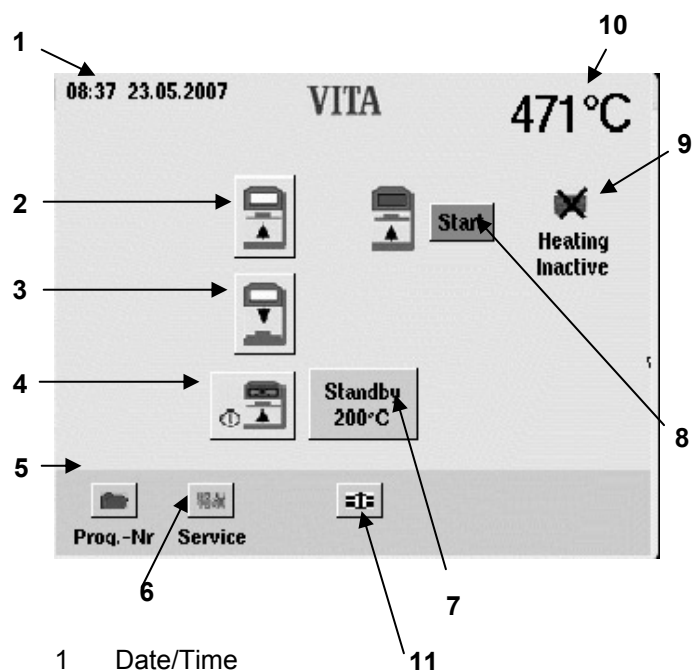

- 1 Date/Time
- 2 Lift button up
- 3 Lift button down
- 4 Shut down unit
- 5 Program selection
- 6 Change to Service programs
- 7 Change standby temperature
- 8 Start = standby
- 9 Heating off
- 10 Firing chamber temperature
- 11 Quick cooling (see section 14)

The display is solely to be operated with the stylus supplied for this purpose.

The use of other means for operation will cause damage to the touchscreen and possible malfunctions.

After switching on the unit the display shows the main menu.

- Switch on the unit by the main switch.
- The lift moves to bottom position
- The main menu is displayed.

13 Standby

13.1 Adjustment of standby temperature

- Press button "Standby" (1) in the start menu.

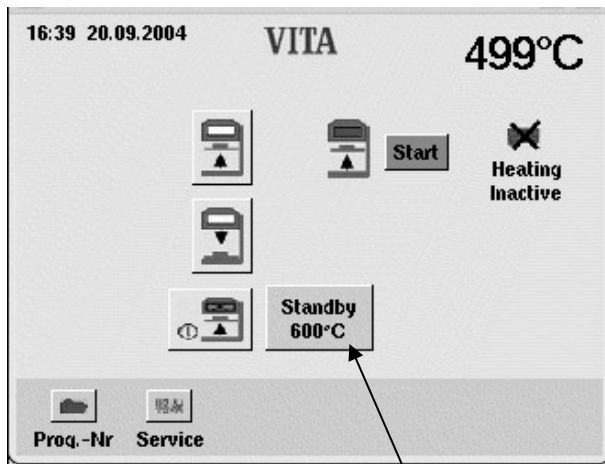

1

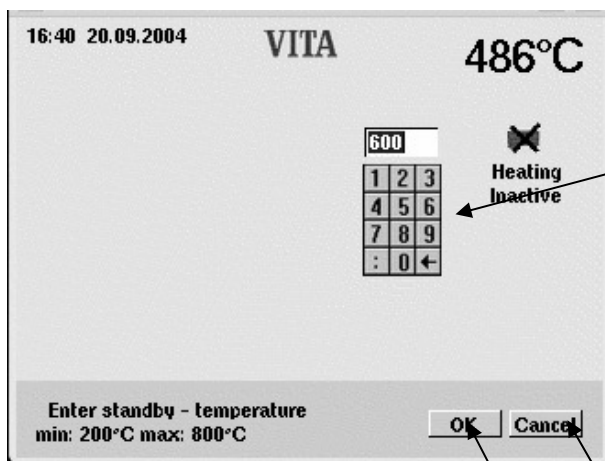

3

4

- Enter a value via the numerical keypad (2).
- Press button "OK" (3) to confirm or "Cancel" (4) without changing the temperature.

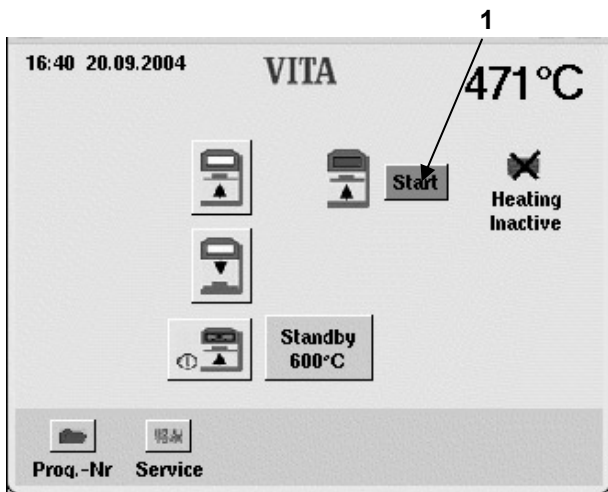

13.2 Start/stop standby mode

- Press button "Start" (1) in the start menu.
- Press button "Open" (2), switch on the heating, the lift moves down to bottom position.

or

- Press button "Stop" (3), quit standby mode, switch off the heating, the lift moves down to bottom position.

or

- Press button "Close", switch on the heating, the lift moves up to top position.

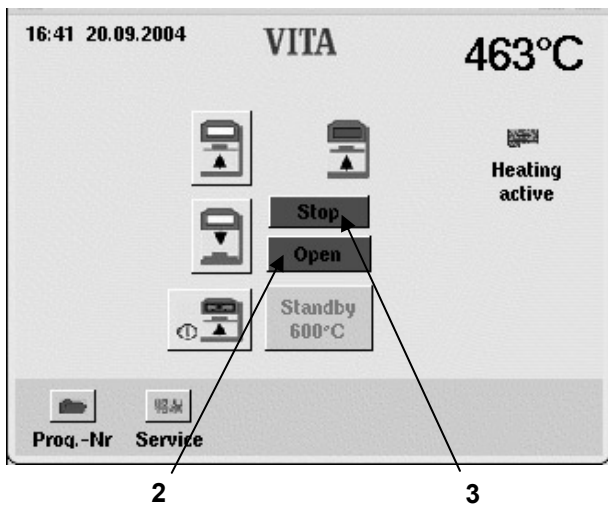

If no further operation takes place within 5 minutes the heating will switch off.

In standby mode the following functions are available for selection:

- Lift buttons
- Program selection
- Service
- Shut down unit

14 Selecting a firing program

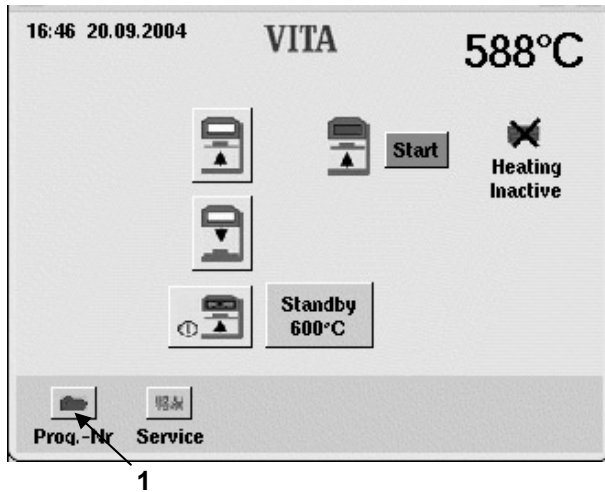

- Press button "Prog. No" (1) in the start menu.

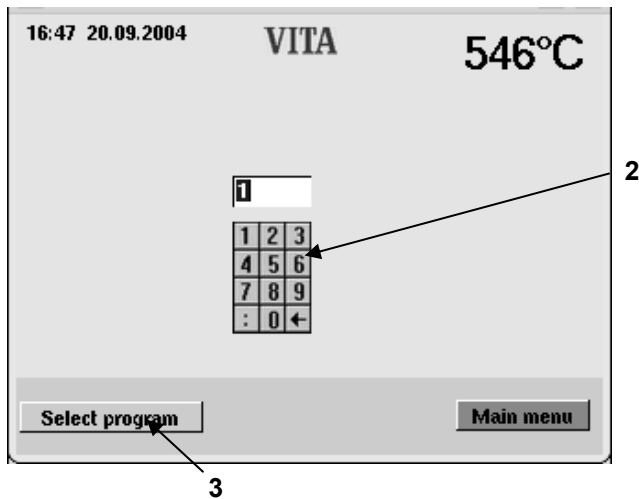

- Enter a program no. (No. 1 – 200) with the keypad
- Press button "Select program" (3).

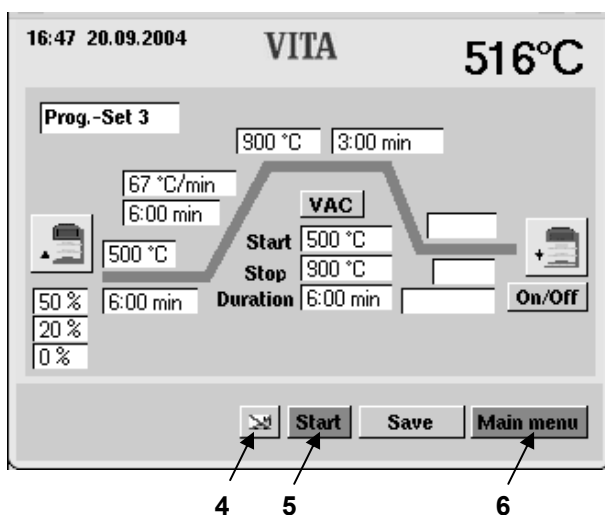

- i** **Night program (4):**
 After expiration of the program and cooling down to 200 °C the lift is retracted and the display switched off.
 Press key (4) to switch on.
 Active night mode is indicated.

- Press button "Start" (5) to start the program.
- Press button "Main menu" (6) to return to the start menu.

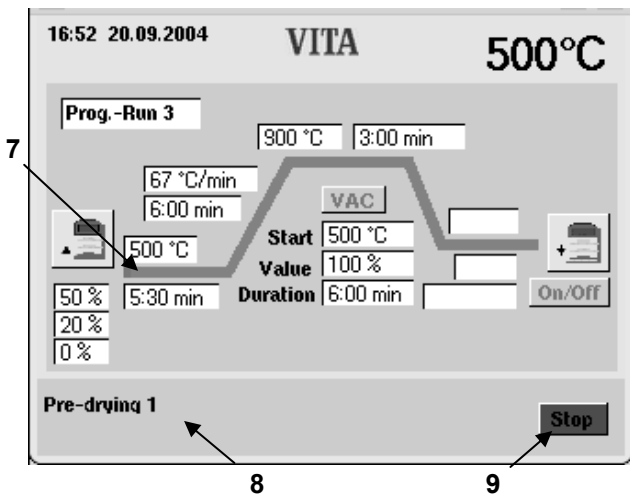

The Info bar (8) shows the active program section.

The chronological sequence is displayed green in the firing curve (7).

- Press button "Stop" (9) to terminate the program.

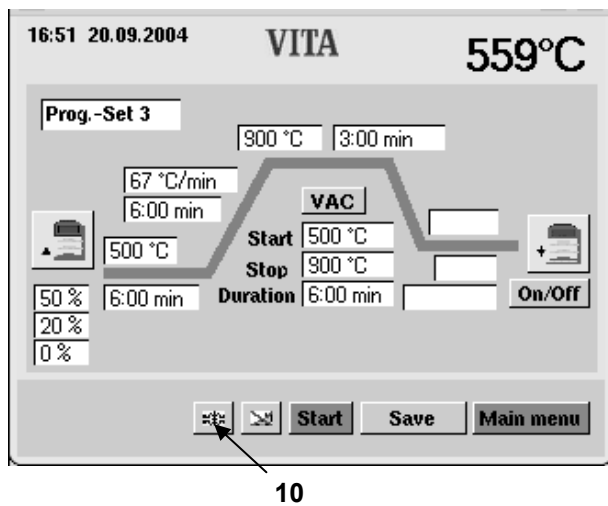

A buzzer will sound at the end of the program.

i Quick cooling (10):

The pump is switched on, at a firing chamber temperature of 50 °C below the standby temperature the lift is retracted and heated up again to standby temperature.

The symbol "Quick cooling" (10) is only displayed if the temperature in the firing chamber is higher than the standby temperature.

15 Changing program values

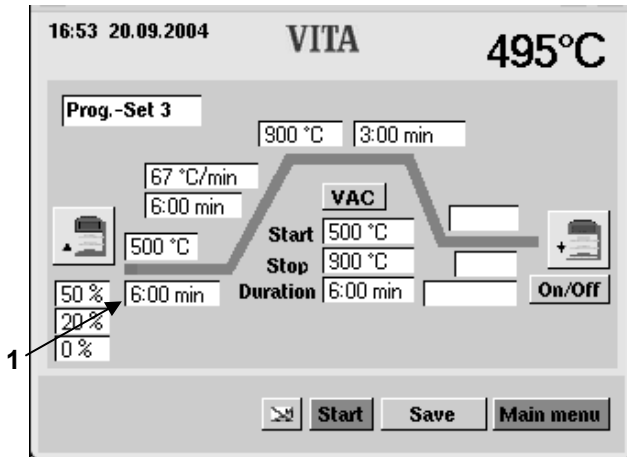

- Press button "Prog. No" in the start menu.
- Enter the program-no.
- Press button "Select program".

The process for changing program values is explained on the example for changing the pre-drying time.

- Press field "Pre-drying time" (1).

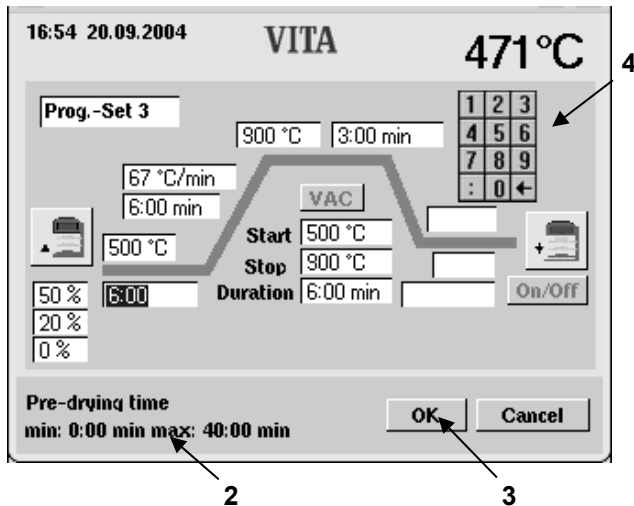

The field is highlighted. The Info bar (2) shows the possible input values.

- Enter a value via the numerical keypad (4).
- Press button "OK" (3) to confirm.

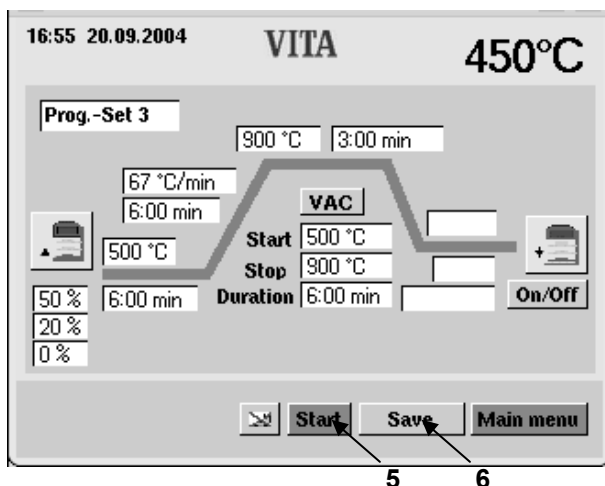

Do not save value

- Press button "Start" (5).
The program runs with changed values. After the sequence return to the originally saved value.

Save value

- Press button "Save" (6).
- Press button "Yes".
- Press button "Start" (5).
The value is saved, the program continues with the changed value. After expiration the value remains in the memory.

This sequence applies for changes to all program values.

16 Lift positions for pre-drying

For the pre-drying phase 3 lift positions are available.

- Pos. 1 – bottom position – the possible input value is 0 – 30 %, the time value 0 – 2:00 Min.
- Pos. 2 – middle position – the possible input value is maximum 50 %, the time value 0 – 2:00 Min
- Pos. 3 – top position – the input value is maximum 80 %, the time value is the difference to the pre-drying time and is determined and entered automatically.

The basic values ex factory are:

- Pos. 1 = 0 % time = 2:00 Min.
- Pos. 2 = 20 % time = 2:00 Min.
- Pos. 3 = 50 % time = 2:00 Min.

When changing a pre-drying time by more than 6:00 Min the time for Pos. 1 and Pos.2 is maintained and the time for Pos. 3 is extended accordingly.

When changing a pre-drying time of less than 3:00 Min pre-drying is performed in Pos. 2 with lift position 50 %.

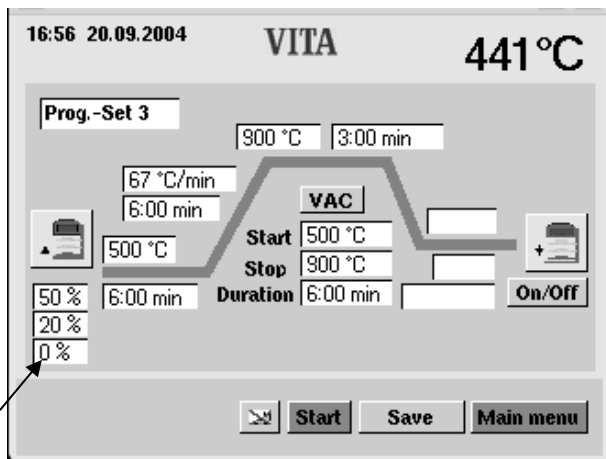

16.1 Direct input of changes for lift position and position time.

- Press button "Prog. No" in the start menu.
- Enter the program-no.
- Press button "Select program".

Example: Change of lift position 1:

- Actuate the field "Lift position 1" (1).

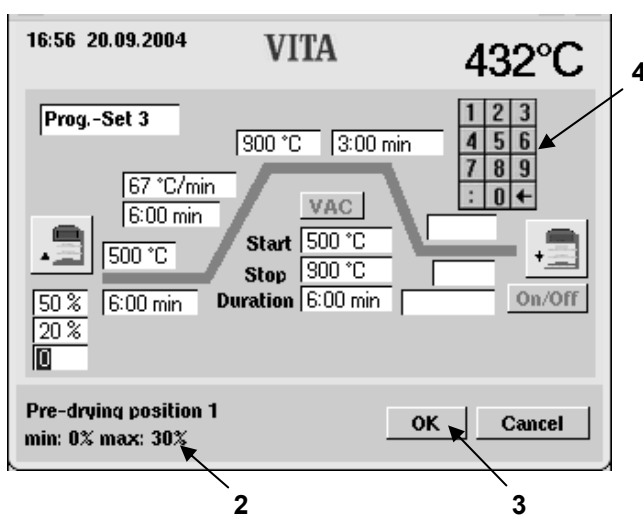

The field is highlighted. The Info bar (2) shows the possible input values.

- Enter a value via the numerical keypad (4).
- Press button "OK" (3) to confirm.

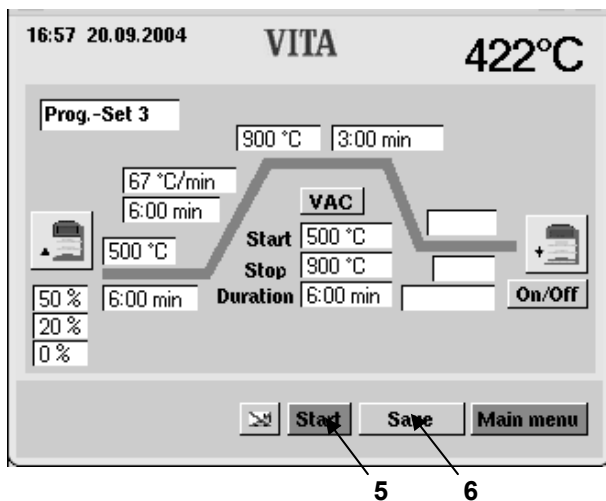

Do not save value

- Press button "Start" (5).
The program runs with changed values. After the sequence return to the originally saved value.

Save value

- Press button "Save" (6).
- Press button "Yes".
- Press button "Start" (5).
The value is saved, the program continues with the changed value. After expiration the value remains in the memory.

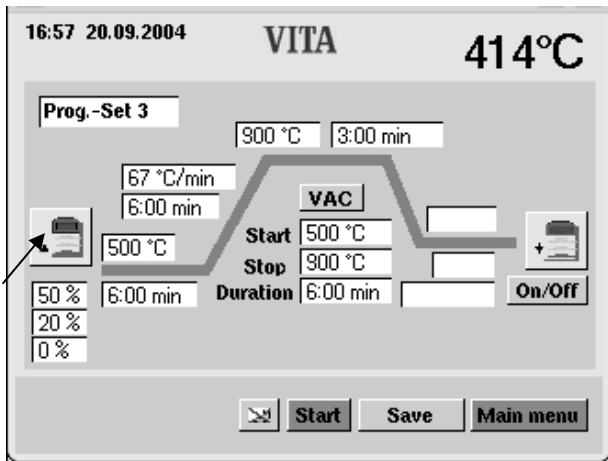

16.2 Input of changes to lift position and position time in the pre-drying menu .

- Press button "Prog. No" in the start menu.
- Enter the program-no.
- Press button "Select program".
- Press symbol "Pre-drying" (1).

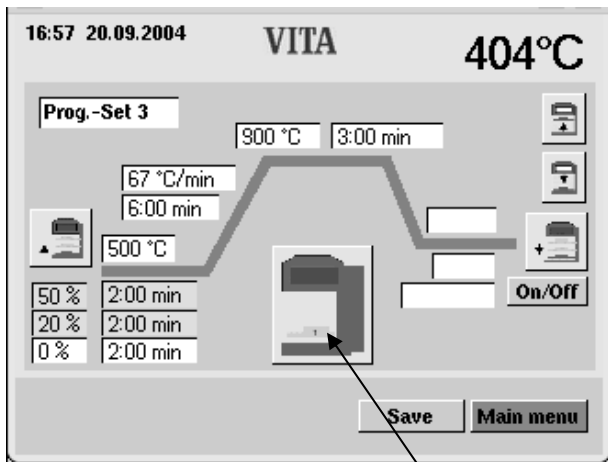

- Press symbol "Lift position" (2).
The lift travels to position 1, 2 or 3.
The fields Pos. and Time belonging to the position are highlighted in colour, except the Time for Pos. 3. This is automatically determined, inputs are not possible.

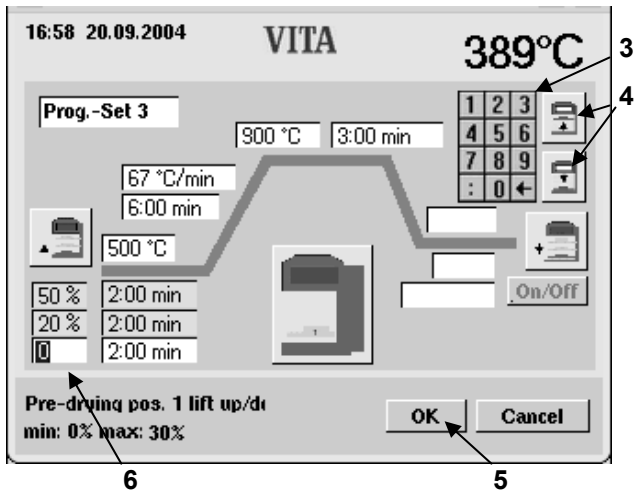

The positions are changed as follows:

- Actuate the position field (6).
- Enter the value via the keypad (3).
- Press button "OK" (5).

or

- Move the lift to the desired position with the lift keys (4).
- Press button "OK" (5).

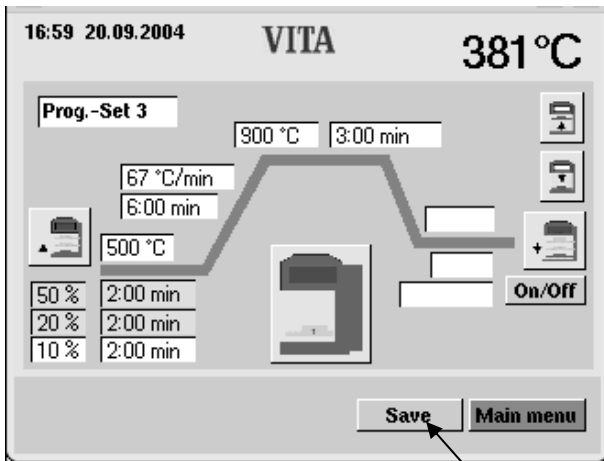

- Press button "Save" (7).

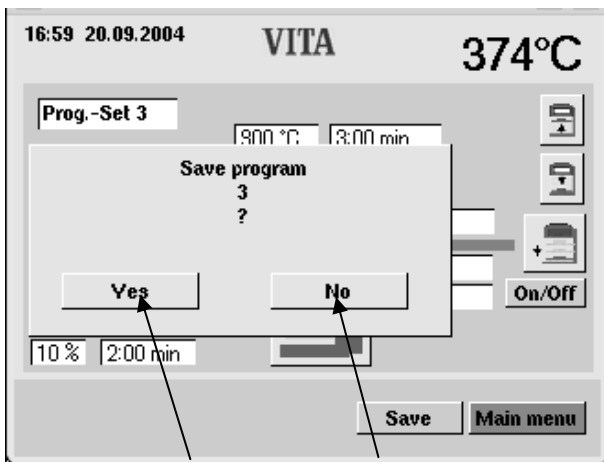

Save changes:

- Press button "Yes" (8).

Changes for a program sequence:

- Press button "No" (9).

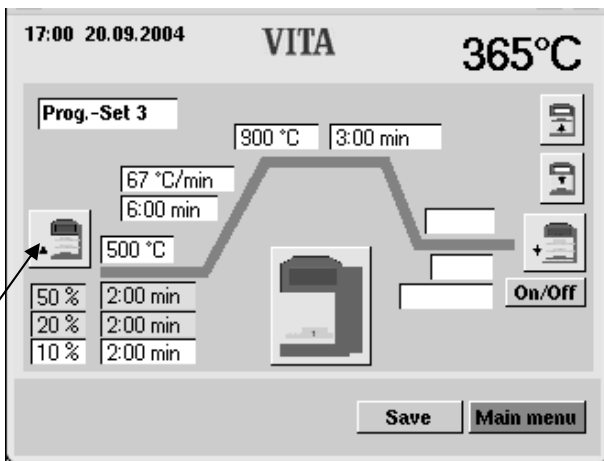

- Press button "Symbol" (10).

17 Lift positions for cooling

- Press button "Prog. No" in the start menu.
- Enter the program-no.
- Press button "Select program".
- If cooling is not activated press button "Cooling On/Off" (1), basic values are displayed.

17.1 Direct input of changes to the lift position cooling

- Press button "On/Off" (1) to activate cooling.

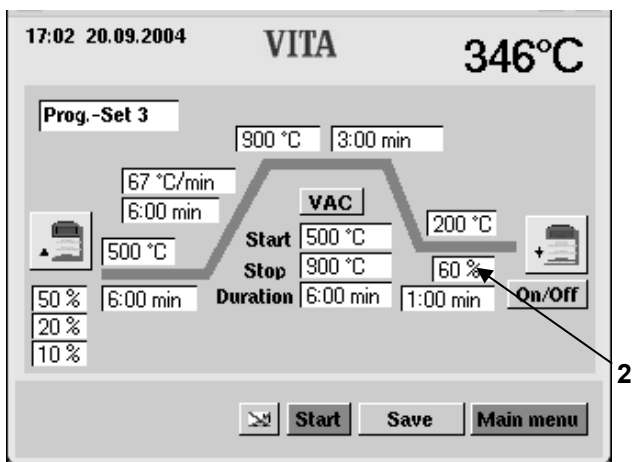
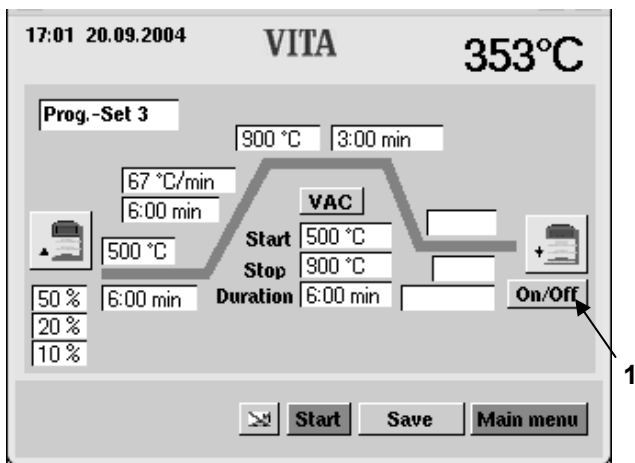

- Actuate the field for "Lift position" (2), the keypad (3) is displayed.

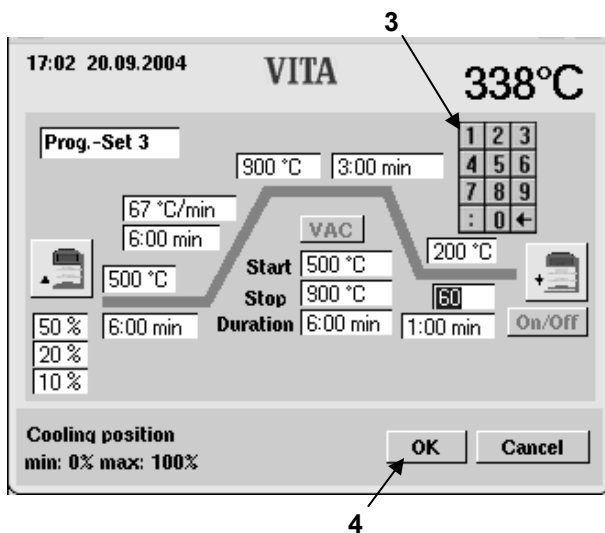

- Enter the value.
- Press button "OK" (4).

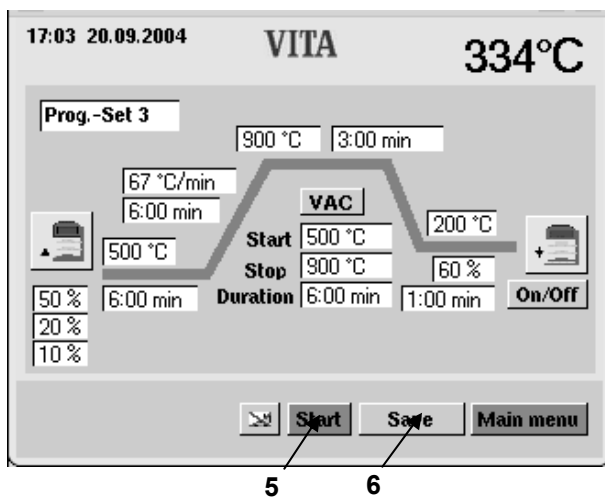

- Press button "Start" (5).
After expiration the original value is restored.

or

- Press button "Save" (6).
- Press button "Yes".
(Button "Yes" is displayed after the button "Save" has been actuated).

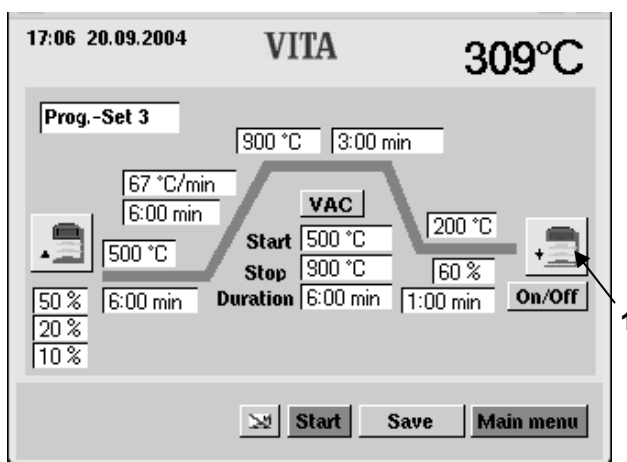

17.2 Entering a change of lift position cooling in the cooling menu

- Press symbol "Cooling" (1).
("Cooling" must be active.)

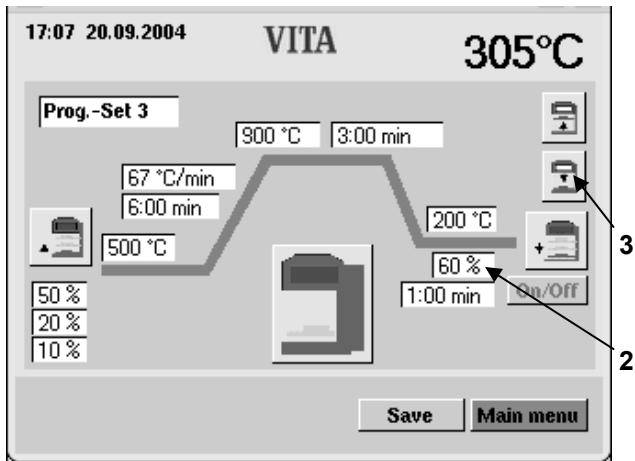

- Press input field "%" (2) or button "Lift" (3).

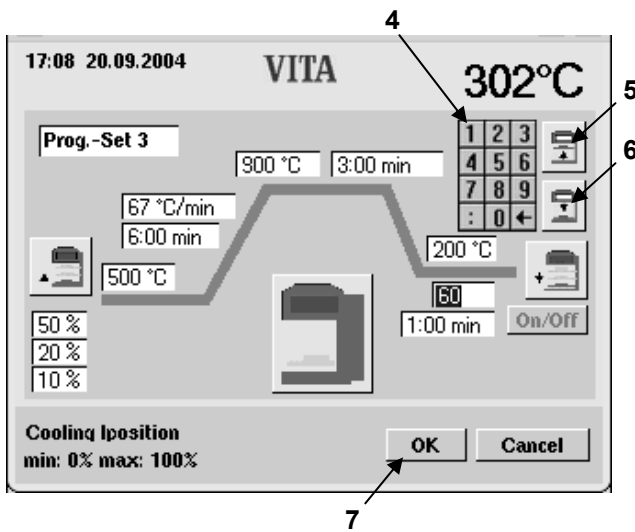

- Enter the value (4).
- or
- Press button "Lift up" (5) or "Lift down" (6).
- Press button "OK" (7).

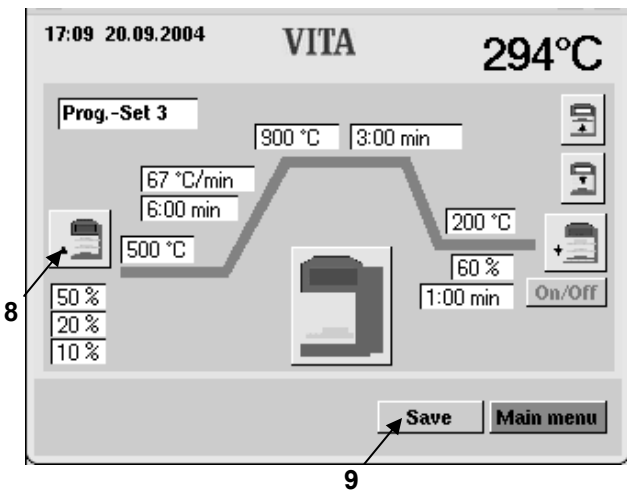

- Press symbol "Cooling" (8). Start the program with changed value. After expiration the original value is restored.
- or
- Press button "Save" (9).
 - Press button "OK". (Button "OK" is displayed after the button "Save" has been actuated).
 - Press symbol "Cooling" (8).
 - Start the program with changed value.

18 Vacuum settings

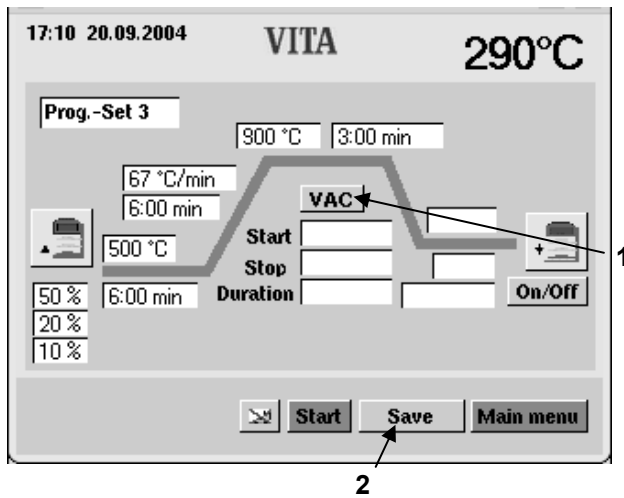

- Press button "Prog. No" in the start menu.
- Enter the program-no.
- Press button "Select program".
- Press button "VAC" (1) Activate/deactivate vacuum.
- Press button "Save" (2).

When choosing "On" the basic values will be accepted.

"Start" = with start of temperature rise.

"Stop" = Final temperature.

"Duration" = like rise time

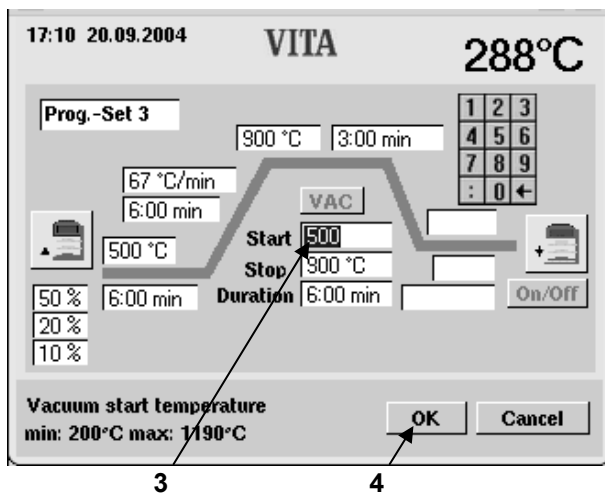

Example: Change of start temperature

- Actuate the field "Start" (3), the keypad is displayed.
- Enter the value.
- Press button "OK" (4), the image changes.
Start the program with changed value.
After expiration the original value is restored.

or

- Press button "Save" (2).
- Press button "Yes".



In case of program changes, for pre-drying temperature/start temperature, end temperature and rise time the times for switching on and off are automatically adapted.

The pump running time is identical with the rise time.

The vacuum display shows the value in %. On the basis of atmospheric pressure of 1000 mbar at sea level:

100 %	=	- 1000 mbar (cannot be reached)
95 %	=	- 950 mbar or 50 mbar absolute
90 %	=	- 900 mbar or 100 mbar absolute

The vacuum value reached depends on the power of the vacuum pump used and is in the range from 85 - 95 % (150 mbar - 50 mbar absolute)

If the vacuum value of 30 % within a period of approx. 15 seconds during the course of a firing program, the firing program will be aborted and the error message Vacuum within 15 s < 30 % is displayed (see section 22 "22").

Formation of condensation water in the firing chamber insulation and in the vacuum pump results in a lesser vacuum and therefore to poorer firing results.

For this reason the lift should be retracted when the unit is switched off, thus to avoid the absorption to moisture.

19 Service programs

- Press button "Service" in the start menu.

The individual sections are activated by touching with the pin.

Possible changes are saved by actuating the button "Accept".

17:11 20.09.2004		VITA		284°C	
Info Language Screen Process data Date / Time Display formats Lift speed Operating data Calibrations Programs	Version op.	9.23	Update		
	Version CORE	9.04			
	Device-ID op.				
	Device-ID CORE	820040052			
	VITA	+49 7761 562 222			
	Dealer	VITA			
	Factory Settings				
	www.Vita-Zahnfabrik.com				Main menu
	Accept				

17:11 20.09.2004		VITA		284°C	
Info Language Screen Process data Date / Time Display formats Lift speed Operating data Calibrations Programs	Version op.	9.23	Update		
	Version CORE	9.04			
	Device-ID op.				
	Device-ID CORE	820040052			
	VITA	+49 7761 562 222			
	Dealer	VITA			
	Factory Settings				
	www.Vita-Zahnfabrik.com				Main menu
	Accept				

19.1 Information about the unit/Software

Version cont.	= Software of control unit
Version core	= Software for core
Unit – ID cont.	= Serial-no. of control unit
Unit – ID core	= Serial-no. of core
VITA	= Hotline phone-no.
Dealer	= VITA

Concerning the button "Update" see section "20".

Concerning the button "Factory Setting" see section 21".

08:34 23.05.2007		VITA		44°C
Info Language Screen Process data Date / Time Display formats Lift speed Operating data Calibrations Programs	Language			
	<input type="radio"/> German	<input type="radio"/> Slovenian		
	<input checked="" type="radio"/> English	<input type="radio"/> Romanian		
	<input type="radio"/> French	<input type="radio"/> Finnish		
	<input type="radio"/> Italian	<input type="radio"/> Czech		
	<input type="radio"/> Spanish	<input type="radio"/> Portugalec		
	<input type="radio"/> Chinese			
	<input type="radio"/> Japanese			
	<input type="radio"/> Russian			
	<input type="radio"/> Danish			
<input type="radio"/> Turkish				
www.Vita-Zahnfabrik.com				Main menu
Accept				

19.2 Language selection

- Select the desired language.
- Press button "Accept".
- Press button "Main menu".

 The actual screen display may vary from the opposite illustration.

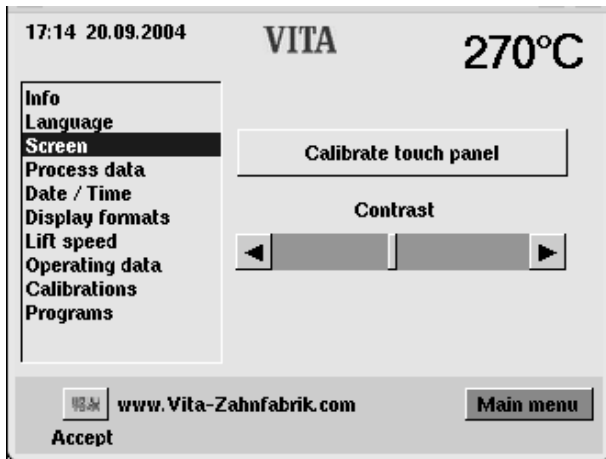

19.4 Screen settings

Calibrating the touch panel

This calibration must be carried out when actuation of a field on the screen does not trigger any action of the desired function.

- Operate the button "Calibrate touch panel".
- Keep on pressing the dots appearing on the dark display, until the display lights up.

Contrast

- Adjust the desired contrast with the slide switch.
- Press button "Accept".

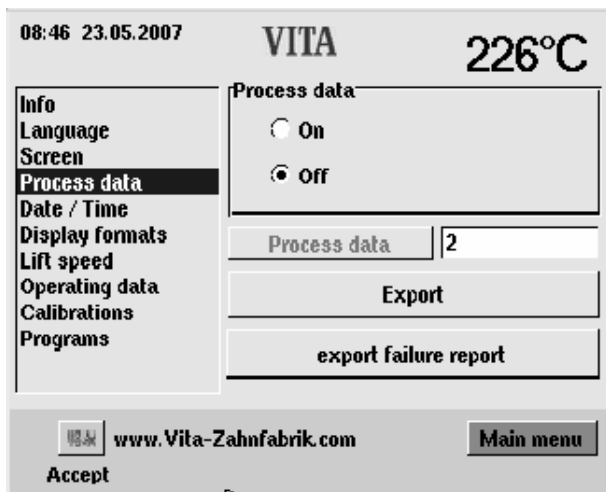

19.5 Process data

see also section "4".

"On" = Process data are saved in the control unit.

"Off" = Process data will not be saved.

"Process data" = Number of saved firing programs.

"Export" = Copies firing data to the Memory Stick (see also section 4).

19.3 Export failure report

Generally, the previous 10 firing programs that have been run are saved.

If an unsatisfactory firing result is obtained or failure has occurred in the program sequence, the failure report can be exported on a memory stick and emailed to instruments-service@vita-zahnfabrik.com for analysis.

An immediate analysis of the failure report is carried out and sent back to the customer.

19.6 Loading firing programs from the Memory Stick

Saved firing programs are exported to the Memory Stick (see also section 4).

- Plug in the Memory Stick in the main menu.
- Press button "Service".
- Press button "Info".
- Press button "Update"

Firing data are transferred to the Memory Stick

After the transfer change to the main menu and pull out the stick.



19.7 Date - Time

- Actuate "Date/Time".

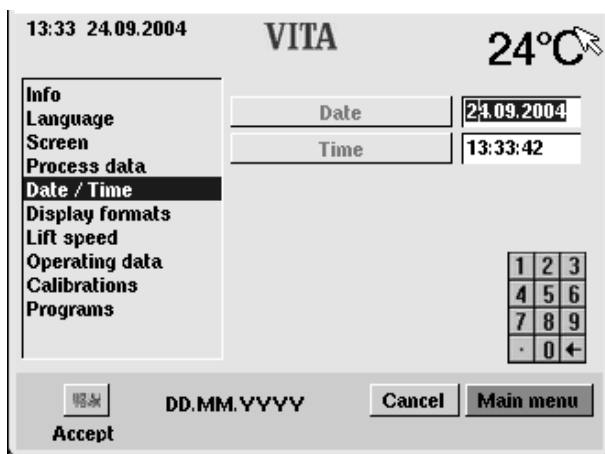

- Press field "Date" or "Time".
Input date = DD: MM: YY
Input time = HH: MM
see also section "Display formats".
- Press button "Accept".

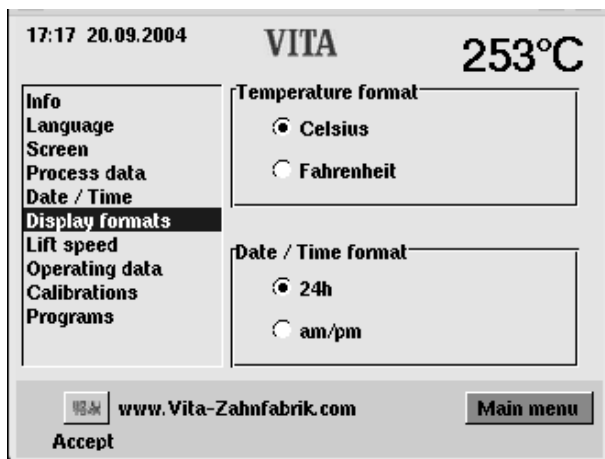

19.8 Display format

Adjustment for temperature display:

Temperature display in °C

or

Temperature display in °F

Setting Date/Time:

24 h or am/pm

- Actuate the desired option.
- Press button "Accept".

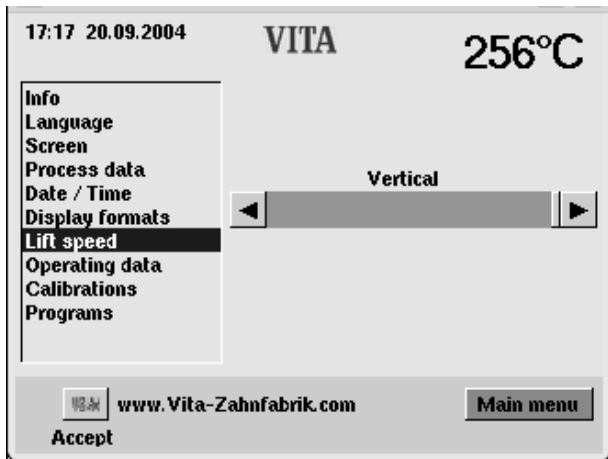

19.9 Lift speed adjustment

Adjust the lift speed with the slide control.

- Operate the slide control.
- Press button "Accept".

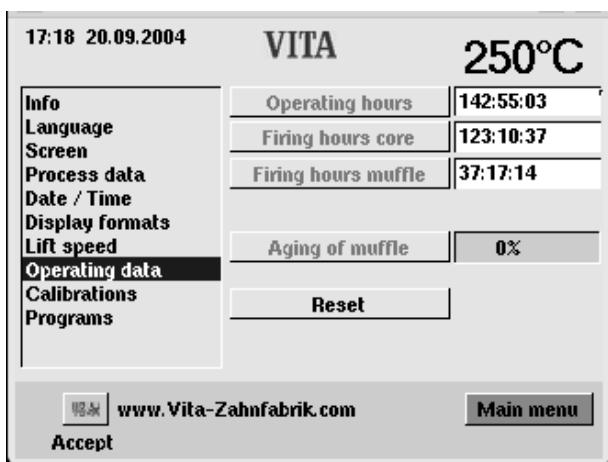

19.10 Operating data

Operating hours:

Total time of unit

Firing hours of heating:

Total firing time

Firing hours of heating:

Firing hours of firing muffle

Degree of aging of firing muffle:

Display in %, related to 4000 firing hours.

19.11 Temperature calibration by means of silver test

With this program and the VITA – Silver Text Set (VITA – Order-No. B 230) the temperature in the firing chamber can be checked and readjusted within the range of plus/minus 20 °C. When adjusting make sure that the instructions for the performance (instructions in the silver test set) of the test with the silver sample are strictly applied. Negligence will cause measuring faults and therefore incorrect adjustments.

There is a default program available for the adjustment of the firing chamber temperature.

For testing the firing chamber temperature by means of the silver sample 2 program runs are required. The first program run must be performed at 955 °C (preset in the program), the silver should not have been fused.

The second program run must be performed at 965 °C, this temperature value must be entered.

After this program run the silver must have been fused ball.

Deviations within the range of plus/minus 20 °C can be entered.

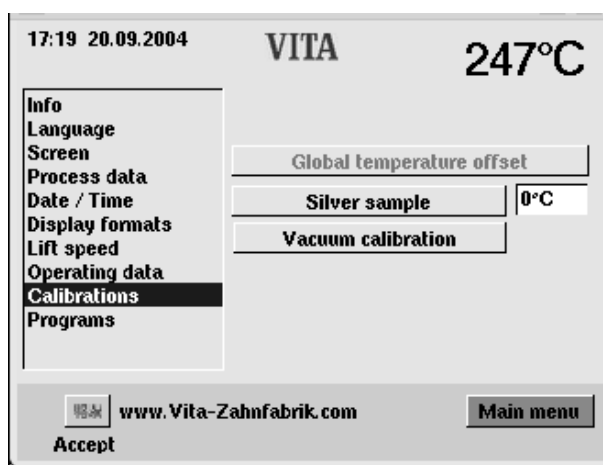

Input "Global temperature offset":

- Actuate the field "°C", the keypad is displayed.
- Enter the value.
- Press button "Accept".



Example:

temperature about 15°C to high

=> insert +15°C

temperature about 15°C to low

⇒ insert -15°C

Vacuum calibration, see also section 19.12.

- Press button "Vacuum calibration".
The lift is retracted, the pump switched on, the display shows the vacuum value.

19.12 Vacuum calibration



Before starting make sure that the vacuum pump works with full power and that the vacuum system (seals) in the firing unit is in good conditions.

A too low vacuum caused by leaks in the system **cannot** be compensated with this program.

- Check the power of the vacuum pump with a vacuum tester, independently from the firing unit.

The vacuum system of the firing unit can be checked as follows:

- Start program with vacuum.
- Once the max. vacuum value is reached (display does not rise any further), pull the mains connection for the pump off the firing unit.

The vacuum display does not drop:

- Perform vacuum calibration.

The vacuum display drops:

- Check the seals in the firing unit.
A rapid drop in vacuum indicates a leak in the vacuum system, the full vacuum value is not reached.

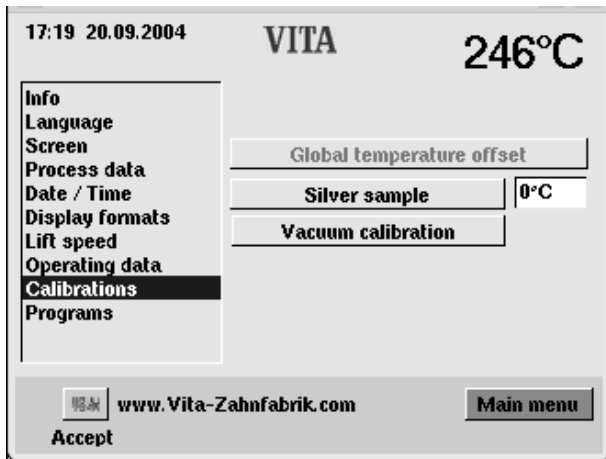

Perform vacuum calibration

Before calibrating see section 19.12.

- Press button "Vacuum calibration".
The vacuum pump starts, the field for vacuum value is displayed, once the maximum vacuum value is reached the pump switches off and the lift moves to bottom position.
- Press button "Accept".

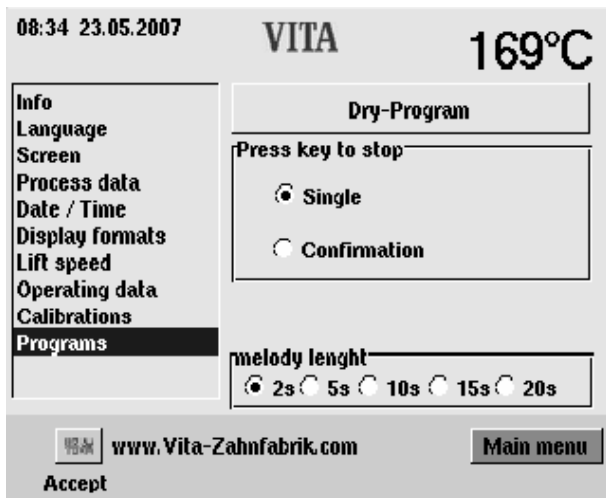

19.13 Programs

"Press Stop button"

"Single" = Abort program without confirmation.

"Confirmation" = Abort program with confirmation.

- Choose "Without confirmation" or "With confirmation".
- Press button "Accept".

19.14 Melody for end of program

- Select desired length.
- Press Accept button.

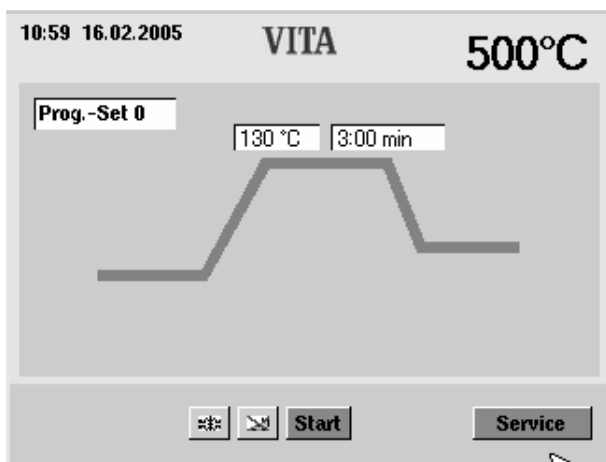

19.15 Dry – Program (Vita In-Ceram sprint)

Temperature area 130°C – 700 °C

Holding time for end temperature 0-60:00Min

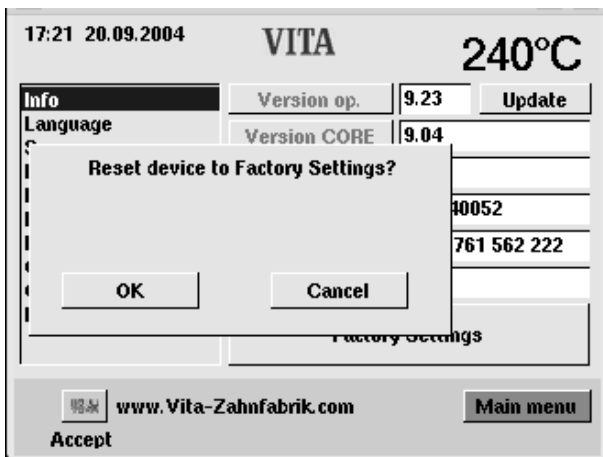

20 Software Update

A software update is loaded from the Memory Stick into the control unit.

The opposite directory must be created on the Memory Stick. The name of the storage medium may be different.



Observe the use of small initial letters.

The software update is copied into the directory "Update".

Transfer the update into the control unit as follows:

- Switch off the unit by the main switch.
- Plug in the Memory Stick.
- Switch on the unit by the main switch.
- Press button "Service".
- Press button "Info".
- Press button "Update", the software is transferred.
- Press button "OK" after the end of the transfer.

21 Factory settings

With "Factory Settings" the following functions are reset to factory settings:

- Firing programs acc. to VITA firing table, see section. **23**
- Contrast see section 19.4
- Language English, see section **19.2**
- Time format to DD:MM:YY, see section 19.7
- Stop single push button contact, see section 19.13
- Process data off, see section **19.5**

Temperature display °C, see section **19.8**



All programs deviating from the VITA table are thereby deleted.

22 Error messages

Message in display	Detection	Test/remedy
Vacuum not reached	If a value of at least 30 % is not reached within 30 seconds, the program with vacuum is aborted.	<ul style="list-style-type: none"> • Check/clean/replace the lift plate seal • Clean the sealing edge on the firing chamber floor. Cleaning work see section 8.3 • Check vacuum pump independently from unit. • Check firing unit vacuum system. See also section 19.12. • Perform vacuum calibration. See also section 0.
Vacuum measurement not calibrated.	Information in display	<ul style="list-style-type: none"> • Perform vacuum calibration. See also section 0.
Fan does not work	The running firing program is terminated.	<ul style="list-style-type: none"> • Check fan connection X7 on printed circuit board. • Clean/replace fan.
Lift blocked	The lift moves too far down	<ul style="list-style-type: none"> • Limit switch for bottom position does not work. Check limit switch connection X 8 on printed circuit board, the associated LED must light when the limit switch is operated. • Check/adjust/replace the limit switch.
The temperature in the firing chamber is higher than 1200 °C	The display shows a reading of more than 1200 °C	<ul style="list-style-type: none"> • This fault can have several different reasons, detection/rectification of this fault requires expert knowledge and the use of technical measuring equipment. • Replace the CPU – board.
Temperature sensor 1 defective	Program is aborted	<ul style="list-style-type: none"> • Check connection of thermo element X 20 on the printed circuit board. • Check the connection of the thermo element on the firing chamber. • Check the connection of the thermo element in the firing chamber. • Check thermo element – replace thermo element.
Battery discharged.	Information in display	<ul style="list-style-type: none"> • Replace the battery on the CPU - board
The nominal temperature has been fallen short of/exceeded for longer than 5:00 Min.	Information in display	<ul style="list-style-type: none"> • Heating defective • Heating too slow • Triac defective • Triac control defective

Message in display	Detection	Test/remedy
The temperature control has caused a fault.	Temperature rise does not comply with the specified time.	<ul style="list-style-type: none"> • Old heating or Triac
The heating cannot be correctly addressed.	No or too fast temperature rise	<ul style="list-style-type: none"> • Firing muffle defective, replace.
The core does not react.	Information in display	<ul style="list-style-type: none"> • Check connecting cable furnace – control. – Replace connecting cable • Check connecting plug for control. – Replace the control. • Check connecting plug for furnace – Replace connecting plug
Permanent sound of approx. 6 seconds	Permanent sound	<ul style="list-style-type: none"> • Fuse defective, see section 8.5 • Replace defective fuse • Check heater connection on circuit board Replace CPU – circuit board

23 Firing tables

23.1 VITA VM 7

	Progr. no.	Pre-drying	→ min.	↗ min.	↗ °C/min	Temp. approx. °C	→ min.	VAC min.
BASE DENTINE Wash firing*	70	500	2.00	7.30	60	950	1.00	7.30
MARGIN firing	71	500	6.00	6.00	60	960	1.00	7.40
EFFECT LINER firing	53	500	6.00	8.11	55	950	1.00	8.11
1 st dentine firing	54	500	6.00	7.27	55	910	1.00	7.27
2 nd dentine firing	55	500	6.00	7.16	55	900	1.00	7.16
Fixing firing of stains	56	500	6.00	3.00	100	800	-	-
Glaze firing	57	500	-	5.00	80	900	1.00	-
Glaze firing VITA Akzent Fluid	58	500	4.00	5.00	80	900	1.00	-
Glaze firing VITA Akzent GLAZE	59	500	4.00	5.00	80	900	1.00	---
Corrective firing with VITA VM 7 CORRECTIVE	60	500	4.00	6.00	55	830	1.00	6.00

* Only for VITA In-Ceram AL for inLab

When using dental ceramics, the firing result largely depends on the individual firing procedure of the user, i.e. among other aspects on the type of furnace, the location of the temperature sensor, the firing tray as well as the size of the workpiece during the firing cycles. Our application-technical recommendations for the firing temperatures (regardless whether they have been provided orally, in writing or in the form of practical instructions) are based on numerous own experiences and tests. The user, however, should consider this information only to provide basic values. If surface, transparency and degree of gloss should not correspond to the firing result that is achieved under optimal conditions, the firing procedure must be adjusted correspondingly. The crucial factors for the firing procedure are not the firing temperature displayed by the furnace but the appearance and the surface condition of the firing object after the firing process.

23.2 VITA VM 9

	Progr. no.	Pre-drying	→ min.	↗ min.	↗ °C/min	Temp. approx. °C	→ min.	VAC min.
Thermal pretreatment	72	500	-	5.00	100	1000	15.00	-
EFFECT BONDER firing*	61	500	6.00	6.00	80	980	1.00	6.00
EFFECT BONDER PASTE firing*	62	500	6.00	6.00	80	980	1.00	6.00
BASE DENTINE Wash firing**	85	500	2.00	7.27	60	950	1.00	7.27
MARGIN firing	86	500	6.00	8.21	55	960	1.00	8.21
EFFECT LINER firing	63	500	6.00	7.49	55	930	1.00	7.49
1. dentine firing	64	500	6.00	7.27	55	910	1.00	7.27
2. dentine firing	65	500	6.00	7.16	55	900	1.00	7.16
Glaze firing	66	500	-	5.00	80	900	1.00	-
Glaze firing with VITA Akzent	67	500	4.00	5.00	80	900	1.00	-
Correction firing with CORRECTIVE	68	500	4.00	4.20	60	760	1.00	4.20

When using dental ceramics, the firing result largely depends on the individual firing procedure of the user, i.e. among other aspects on the type of furnace, the location of the temperature sensor, the firing tray as well as the size of the workpiece during the firing cycles. Our application-technical recommendations (regardless whether they have been provided orally, in writing or in the form of practical instructions) are based on numerous own experiences and tests. The user, however, should consider this information only to provide basic values. If surface, transparency and degree of gloss should not correspond to the firing result that is achieved under optimal conditions, the firing procedure must be adjusted correspondingly. The crucial factors for the firing procedure are not the firing temperature displayed by the furnace but the appearance and the surface condition of the firing object after the firing process.

*For non-shaded VITA In-Ceram YZ please carry out an EFFECT BONDER firing. ATTENTION: Do not carry out this firing in the case of shaded VITA In-Ceram YZ !

** For shaded VITA In-Ceram YZ please carry out an BASE DENTINE Wash firing. ATTENTION: Do not carry out this firing in the case of non-shaded VITA In-Ceram YZ !

23.3 VITA VM9 VITABLOCS®

	Progr. Nr.	Vt. °C	→ min.	↗ min.	↗ °C/min	Temp. ca. °C	→ min.	VAC min.
Stains-fixation VITA SHADING PASTE	85	500	4.00	5.00	76	880	0.30	-
1. firing	64	500	6.00	7.27	55	910	1.00	7.27
2. firing	65	500	6.00	7.16	55	900	1.00	7.16
Glaze firing VITA SHADING PASTE "glaze"	58	500	4.00	5.00	80	900	1.00	-
Glaze firing VITA Akzent finishing agent	58	500	4.00	5.00	80	900	1.00	-
Corrective firing CORRECTIVE	68	500	4.00	4.20	60	760	1.00	4.20

23.4 VITA VM 13

	Progr. no.	Pre-drying	→ min.	↗ min.	↗ °C/min	Temp. approx. °C	→ min.	VAC min.
Oxidation firing	73	Follow manufacturer's instructions !						
WASH OPAQUE firing	74	500	2.00	5.12	75	890	2.00	5.12
WASH OPAQUE PAST firing	75	500	4.00	5.12	75	890	2.00	5.12
OPAQUE firing	76	500	2.00	5.12	75	890	1.00	5.12
OPAQUE PASTE firing	77	500	4.00	5.12	75	890	1.00	5.12
MARGIN firing	78	500	6.00	7.05	55	890	2.00	7.05
EFFECT LINER firing	79	500	6.00	7.05	55	890	1.00	7.05
1 st dentine firing	80	500	6.00	6.55	55	880	1.00	6.55
2 nd dentine firing	81	500	6.00	6.44	55	870	1.00	6.44
Glaze firing	82	500	-	4.45	80	880	2.00	-
Glaze firing with VITA Akzent	83	500	4.00	4.45	80	880	1.00	-
Glaze firing with CORRECTIVE	84	500	4.00	6.00	50	800	1.00	6.00

When using dental ceramics, the firing result largely depends on the individual firing procedure of the user, i.e. among other aspects on the type of furnace, the location of the temperature sensor, the firing tray as well as the size of the workpiece during the firing cycles.

Our application-technical recommendations (regardless whether they have been provided orally, in writing or in the form of practical instructions) are based on numerous own experiences and tests. The user, however, should consider this information only to provide basic values. If surface, transparency and degree of gloss should not correspond to the firing result that is achieved under optimal conditions, the firing procedure must be adjusted correspondingly. The crucial factors for the firing procedure are not the firing temperature displayed by the furnace but the appearance and the surface condition of the firing object after the firing process.

23.5 VITA VM 15

	Progr. Nr.	Vt. °C	→ min.	↗ min.	↗ °C/min	Temp . ca. °C	→ min.	VAC min.
Oxidation firing	100	Bitte Angaben der Legierungshersteller beachten!						
WASH OPAQUE firing	101	400	2.00	6.00	70	820	1.00	6.00
WASH OPAQUE PASTE firing	102	400	6.00	6.00	70	820	1.00	6.00
OPAQUE firing	103	400	2.00	6.00	70	820	1.00	6.00
OPAQUE PASTE firing	104	400	6.00	6.00	70	820	1.00	6.00
MARGIN firing	105	400	6.00	8.12	50	810	1.00	8.12
EFFECT LINER firing	105	400	6.00	8.12	50	810	1.00	8.12
1. dentine firing	106	400	6.00	8.00	50	800	1.00	8.00
2. dentine firing	107	400	6.00	7.48	50	790	1.00	7.48
Glaze firing	108	400	0.00	4.52	80	790	1.00	-
Glaze firing VITA Akzent	109	400	4.00	4.52	80	790	1.00	-
Glaze firing VITA Glaze Lt	110	400	4.00	4.45	80	780	1.00	-
Correction firing with CORRECTIVE	111	400	4.00	7.00	50	750	1.00	7.00

When using dental ceramics, the firing result largely depends on the individual firing procedure of the user, i.e. among other aspects on the type of furnace, the location of the temperature sensor, the firing tray as well as the size of the workpiece during the firing cycles.

Our application-technical recommendations (regardless whether they have been provided orally, in writing or in the form of practical instructions) are based on numerous own experiences and tests. The user, however, should consider this information only to provide basic values. If surface, transparency and degree of gloss should not correspond to the firing result that is achieved under optimal conditions, the firing procedure must be adjusted correspondingly. The crucial factors for the firing procedure are not the firing temperature displayed by the furnace but the appearance and the surface condition of the firing object after the firing process.

23.6 VITA VMK 95

	Progr. no.	Pre-drying	→ min.	↗ min.	↗ °C/min	Temp. approx. °C	→ min.	VAC min.
Oxidation firing	25	Follow manufacturer's instructions !						
1 st opaque firing (powder)	26	600	2.00	4.00	88	950	1.00	4.00
1 st opaque firing (paste)	27	500	6.00	6.00	75	950	1.00	6.00
2 nd opaque firing (powder)	28	600	2.00	4.00	83	930	1.00	4.00
2 nd opaque firing (paste)	29	500	6.00	6.00	72	930	1.00	6.00
Margin porcelain firing "MARGIN"	30	600	6.00	6.00	55	930	1.00	6.00
1 st dentine firing	34	600	6.00	6.00	55	930	1.00	6.00
2 nd dentine firing	32	600	6.00	6.00	55	930	1.00	6.00
3 rd dentine firing	33	600	6.00	6.00	53	920	1.00	6.00
Correction porcelain firing with COR	34	600	4.00	6.00	50	900	1.00	-
Glaze firing	35	600	-	4.00	83	930	1.00	-
Glaze firing with VITA Akzent® Fluid	36	600	4.00	4.00	83	930	1.00	-
Glaze firing with Glaze Akz25	37	600	4.00	4.00	75	900	1.00	-

In the case of dental ceramics the end result of firing depends to a great extent on how the individual user carries out the firing, i.e. on the type of furnace, the position of the temperature sensor and the firing supports as well as the size of the metal-ceramic construction to be fired.

Our user recommendations for firing temperatures (regardless of whether these are given orally, in writing or by means of practical demonstration) are based on our own wide experience and on many tests. Nevertheless, this information can only be seen as a guideline for the user. Should the surface structure, the transparency or the degree of lustre not correspond to the desired result despite optimum conditions, the firing cycle must be adjusted accordingly. The decisive factor for the firing procedure is not the firing temperature displayed by the furnace, but the appearance and surface quality of the restoration after firing.

To obtain an optimum metal/ceramic bond, the ceramic should be under slight compressive strain. A good end result also depends on the size of the restoration to be fired, the type, hardness and thermal conductivity of the alloy used, and particularly on the way in which each individual technician carries out the firing.

Very good results have been achieved for many years when the thermal expansion coefficient of the alloy – measured from 25 °C – 600 °C – has been between 14.0 and $14.4 \times 10^{-6} \times K^{-1}$ and that of the VITA VMK 95 Metal Ceramics measured from 25 °C – 500 °C between $13.3 - 13.7 \times 10^{-6} \times K^{-1}$.

If the TEC value of the alloy is higher, the temperature range between 900°C to 700°C must not be passed in less than three minutes during the cooling phase.

23.7 VITA OMEGA 900

	Progr. no.	Pre-drying	→ min.	↗ min.	↗ °C/min	Temp. approx. °C	→ min.	VAC min.
Oxidation firing	1	Follow manufacturer's instructions !						
1 st opaque firing (powder)	2	600	2.00	4.00	75	900	2.00	4.00
1 st opaque firing (paste)	3	500	6.00	6.00	67	900	3.00	6.00
2 nd opaque firing (powder)	4	600	2.00	4.00	75	900	1.00	4.00
2 nd opaque firing (paste)	5	500	6.00	6.00	67	900	2.00	6.00
Margin porcelain firing "MARGIN"	6	600	6.00	6.00	50	900	2.00	6.00
1 st dentine firing	7	600	6.00	6.00	50	900	1.00	6.00
2 nd dentine firing	8	600	6.00	6.00	48	890	1.00	6.00
Correction porcelain firing with COR	9	600	4.00	6.00	33	800	1.00	6.00
Glaze firing	10	600	-	4.00	75	900	2.00	-
Glaze firing with VITA Akzent® Fluid	11	600	4.00	4.00	75	900	2.00	-
Glaze firing with Glaze Akz25	12	600	4.00	4.00	75	900	1.00	-

In the case of dental ceramics the end result of firing depends to a great extent on how the individual user carries out the firing, i.e. on the type of furnace, the position of the temperature sensor and the firing supports as well as the size of the metal-ceramic construction to be fired.

Our user recommendations for firing temperatures (regardless of whether these are given orally, in writing or by means of practical demonstration) are based on our own wide experience and on many tests. Nevertheless, this information can only be seen as a guideline for the user. Should the surface structure, the transparency or the degree of lustre not correspond to the desired result despite optimum conditions, the firing cycle must be adjusted accordingly. The decisive factor for the firing procedure is not the firing temperature displayed by the furnace, but the appearance and surface quality of the restoration after firing.

To obtain an optimum metal/ceramic bond, the ceramic should be under slight compressive strain. A good end result also depends on the size of the restoration to be fired, the type, hardness and thermal conductivity of the alloy used, and particularly on the way in which each individual technician carries out the firing.

Very good results have been achieved for many years when the thermal expansion coefficient of the alloy – measured from 25 °C – 600 °C – has been between 14.0 and 14.4 x 10⁻⁶ x K⁻¹ and that of the VITA OMEGA 900 Metal Ceramics measured from 25 °C – 500 °C between 13.4 – 13.9 x 10⁻⁶ x K⁻¹.

If the TEC value of the alloy is higher, the temperature range between 900°C-700°C must not be passed in less than three minutes during the cooling phase.

23.8 VITA TITANIUM PORCELAIN

	Progr. no.	Pre-drying	→ min.	↗ min.	↗ °C/min	Temp. approx. °C	→ min.	VAC min.
Paste bonder firing	38	400	6.00	6.00	67	800	1.00	6.00
Powder bonder firing	39	400	2.00	6.00	67	800	1.00	6.00
Opaque firing	40	400	2.00	4.00	98	790	1.00	5.00
Shoulder firing	41	400	6.00	7.00	53	770	1.00	8.00
1 st dentine firing	42	400	6.00	7.00	53	770	1.00	8.00
2 nd dentine firing	43	400	6.00	7.00	53	770	1.00	8.00
Glaze firing without glaze	44	400	-	4.00	93	770	1.00	5.00
Stains firing*	45	400	4.00	3.00	100	700	1.00	-
Glaze firing with Akzent glaze Akz25	46	400	4.00	4.00	93	770	1.00	5.00

* For stains firing the VITA Akzent stains can be used.

In the case of dental ceramics the end result of firing depends to a great extent on how the individual user carries out the firing, i.e. on the type of furnace, the position of the temperature sensor and the firing supports as well as the size of the metal-ceramic construction to be fired.

Our user recommendations for firing temperatures (regardless of whether these are given orally, in writing or by means of practical demonstration) are based on our own wide experience and on many tests. Nevertheless, this information can only be seen as a guideline for the user. Should the surface structure, the transparency or the degree of lustre not correspond to the desired result despite optimum conditions, the firing cycle must be adjusted accordingly. The decisive factor for the firing procedure is not the firing temperature displayed by the furnace, but the appearance and surface quality of the restoration after firing.

23.9 Soldering in VITA VACUMAT 40 T

Method 1

Preheat the objects in the muffle preheating oven with solder flux and soldering balls for 15-20 minutes at 400 °C.

Program 93

The working temperature of the respective soldering agent + 50°C is the final temperature.

Pre-drying: 5.00 min.

Heating: 5.00 min.

Holding: 3.00 min.

Method 2

Preheat the objects in the muffle preheating oven, but without applied soldering agent for 15-20 minutes at 400 °C.

Program 94

The working temperature of the respective soldering agent + 50°C is the final temperature.

Pre-drying: 1.00 min.

Heating: 3.00 min.

Holding: 4.00 min

A

Alpha numerical inputs · 17
Automatic temperature adjustment · 15

C

CE – Sign · 13
Change of start temperature · 31
Changing program values · 23
Changing the lift position cooling · 28, 29
Changing the pre-drying time · 23
Cleaning · 13
Cleaning the unit · 13
Connecting the unit to the mains supply · 10
Copyright · 5

D

Damage of the touchscreen · 16, 18
Dimensions · 8
Direct input of changes for lift position and position time · 25
Display format · 35
Disposal · 5
Dry – Program · 38

E

Electric data · 8
Error message Vacuum · 32
Error messages · 40
Export failure report · 34

F

Factory settings · 39
Fan · 14
Firing programs · 7
Firing tables · 42
Foreword · 5
Formation of condensation water · 32
Fuses · 13

G

General description · 6

I

Information about the unit · 33
Information decals · 12
Initial start-up of unit · 10
Installation and start-up · 9

Intended use · 11

L

Language selection · 33
Liability · 12
Lift position and position time in pre-drying menu · 26
Lift position cooling · 28, 29
Lift positions for cooling · 28
Lift positions for pre-drying · 24
Lift positions for pre-drying · 25
Lift speed · 36
Lift speed adjustment · 36

M

Melody for end of program · 38
Mounting location · 9

N

Night mode · 11
Notes on safety · 11
Numerical inputs · 16

O

Operating data · 36

P

Perform vacuum calibration · 38
Pictograms · 5
Pre-drying menu · 26
Pre-drying phase · 24
Process data · 34
Program possibilities · 7
Programs · 38

Q

Quick cooling · 22
Quickstarting a firing program · 17

R

Racks · 12

S

Safety functions · 7
Saving of firing data for quality assurance · 7
Scope of delivery · 8

Screen settings · 34
Selecting a firing program · 21
Service programs · 7, 33
Shutting down the unit · 11
Software Update · 39
Soldering in VITA VACUMAT® 40 T · 47
Spare parts · 14
Standby · 19
Start menu · 18
Start/stop standby mode · 20
Start-up · 10

T

Technical information · 6
Temperature adjustment · 15
Temperature rise · 15
Template for customized programs · 48
Time · 35

V

Vacuum calibration · 37
Vacuum display · 32
Vacuum settings · 31
Vacuum value · 32
Vita In-Ceram sprint · 38
VITA OMEGA 900 · 46
VITA TITANKERAMIK · 46
VITA VM 13 · 43
VITA VM 15 · 44
VITA VM 7 · 42
VITA VM 9 · 42
VITA VM9 VITABLOCS · 43
VITA VMK 95 · 45
Voltage failure protection · 14
Voltage supply failure · 14

W

Weights · 8

With the unique VITA SYSTEM 3D-MASTER® all natural tooth shades are systematically determined and completely reproduced.

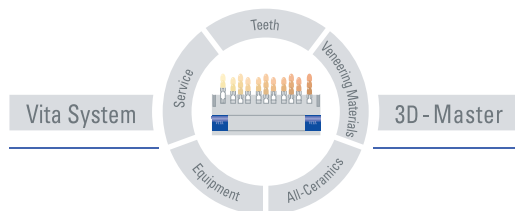

Please note: Our products should be used according to the working instructions. We cannot be held liable for damages resulting from incorrect handling or usage. The user is furthermore obliged to check the product before use with regard to its suitability for the intended area of applications. We cannot accept any liability if the product is used in conjunction with materials and equipment from other manufacturers which are not compatible or not authorized for use with our product. Furthermore, our liability for the correctness of this information is independent of the legal ground and, in as far as legally permissible, is limited to the invoiced value of the goods supplied excluding turnover tax. In particular, as far as legally permissible, we do not assume any liability for profit loss, for indirect damages, for consequential damages or for claims of third parties against the purchaser. Claims for damages based on fault liability (culpa in contrahendo, breach of contract, unlawful acts, etc.) can only be made in the case of intent or gross negligence. Date of issue of these directions for use: 05-07.



VITA

VITA Zahnfabrik H. Rauter GmbH & Co. KG
Postfach 1338 · D-79704 Bad Säckingen/Germany
Tel. +49/(0)7761/562-0 · Fax +49/(0)7761/562-299
Hotline: +49/(0)7761/562-222 · Fax +49/(0)7761/562-446
www.vita-zahnfabrik.com · info@vita-zahnfabrik.com